



PORTS OF
TILBURY
AND
TILBURY2
LONDON

Mooring Operations Manual



Marine Department
Port of Tilbury London Ltd. and
Tilbury2 Ltd.

Version 2.1
Issued: September 2024

This document was first issued in March 2017 to standardise the mooring practices within the Port of Tilbury and for both employees and approved external contractors. Now this also will include the addition of the Port of Tilbury2.

The manual will be periodically reviewed by the Harbour Master and amendments will be disseminated through Notices to Mariners.

Amendments to this manual are listed below:

This manual is **EDITION No. 1** and is **VERSION No. 8**.

Version No.	Date	Section Amended
1.7	10/02/2016	New edition published.
1.8	04/10/2018	Section 4 updated.
1.9	08/03/2019	To now include Port of Tilbury2
2.0	02/03/2020	Includes section on QR Hooks
2.1	09/09/2024	General update: Shorts, pictures and tidy up

FORTH PORTS LIMITED	Document ID PoT PMSC OP13/04	Authorised By Deputy HM	Original Date 10/02/16
Mooring Manual	Date Revised Sep 2024	Revised By AMM	Review Due Sept 2027

1.	INTRODUCTION	3
2.	LEGISLATION, REGULATIONS & CODES OF PRACTICE	3
3.	GENERAL SAFETY RULES	5
4.	LIFE JACKETS & OTHER PERSONAL PROTECTIVE EQUIPMENT	9
5.	MOORING	13
6.	UNMOORING SHIPS	21
7.	USE OF CAPSTANS	22
8.	USE OF HOOKS	24
9.	COMMUNICATIONS & MANPOWER	29
10.	MANUAL HANDLING	0
11.	SAFETY RECOMMENDATIONS SUMMARY	3
2	APPENDIX 1- LOCKSIDE SPECIFIC INFORMATION	4
3	APPENDIX 2 - LCT SPECIFIC INFORMATION	5
4	APPENDIX 3- EDC SPECIFIC INFORMATION	4
	APPENDIX 4- RO-RO BERTH SPECIFIC INFORMATION	7
5	ANNEX 1 - USEFUL KNOTS	9
6	ANNEX 2 - ROPES & MOORINGS (Dos & Don'ts)	12
7	ANNEX 3 - COMMON HAND SIGNALS	13

FORTH PORTS LIMITED	Document ID PoT PMSC OP13/04	Authorised By Deputy HM	Original Date 10/02/16
Mooring Manual	Date Revised Sep 2024	Revised By AMM	Review Due Sept 2027

1. INTRODUCTION

The mooring and unmooring of any vessel are an integral part of the operation at the Port of Tilbury. Mooring crews need to be adequately trained and have suitable experience to ensure a safe operation is carried out. Practical and theoretical training will be given to all those involved in the mooring operation within the port. Part of this training will include, understanding the requirements of the vessel's Master, who has overall responsibility for the safe mooring of their vessel, considering hazards associated with the time of day, location, prevailing weather conditions and tidal conditions at the berth.

2. LEGISLATION, REGULATIONS & CODES OF PRACTICE

Health & Safety at Work Act 1974

Section 2 - Employers General Duties to employees (so far as is reasonably practicable) -

To provide and maintain plant, and systems of work which are safe and without risk to health.

- Provide safe use, handling, storage and transport of articles and substances.
- Provide information, instruction, training and supervision.
- Maintain safe access and egress with regards to any place of work. - Provide adequate welfare facilities.

Section 2 - (Part 3)

- Provide a safety policy, revise it as necessary and bring it to the attention of employees.

1.1.1 Section 3 - Employers General Duties to persons not in their employment (so far as is reasonably practicable)

- Ensure that those not employed are not exposed to any risk to their health and safety from the company's undertakings.

1.1.2 Section 7 - Employees General Duties

- Take reasonable care for your own health and safety and that of others affected by what you do.
- Co-operate with the employer to enable them to discharge their duties.

Section 8

- Do not misuse or interfere with anything provided for safety purposes.

Management of Health and Safety at Work Regulations 1999

1.1.3 Regulation 3 - Risk Assessment

- Make a suitable and sufficient assessment of the risks to the health and safety of employees and others not in employment which they may be exposed to while at work.
- Review the risk assessment if something changes or it is no longer valid.
- Record the risk assessment if the employer employs more than five people.

Regulation 4 - Principles of Prevention

- Apply the principles of prevention when considering controls against risks.

1.1.4 Regulation 10 - Information for Employees

- Provide relevant information regarding the risks to health and safety identified in the risk assessment.
- Preventive and protective measures in place.
- Provide relevant information regarding procedures.

FORTH PORTS LIMITED	Document ID PoT PMSC OP13/04	Authorised By Deputy HM	Original Date 10/02/16
Mooring Manual	Date Revised Sep 2024	Revised By AMM	Review Due Sept 2027

1.1.5 Regulation 11 - Co-operation and Co-ordination

- Where two or more employers share a workplace, they shall co-operate with each other.
- Co-ordinate the work, safety and protection arrangements.
- Inform other employers of the risks to their employee's health and safety arising from or in connection with work.

1.1.6 Regulation 13 - Capabilities and Training

- Provide employees with adequate health and safety training.
- Repeat training where appropriate.
- Adapt the training to consider, any new or changed risks to health and safety. - Training to take place during working hours.

1.1.7 Regulation 14 - Employees Duties

- Use machinery, equipment, dangerous substances, transport equipment, means of production or safety devices provided by the employer in accordance with training.
- Inform the employer or person responsible for health and safety of any work situation that represents a serious and immediate danger.
- Inform the employer or person responsible for health and safety of any work situation that represents a shortcoming in protection arrangements.

Manual Handling Operations Regulations 1992

1.1.8 Regulation 4 - Duties of Employers

- Avoid the need to undertake manual handling activities where practicable.
- Make a suitable and sufficient assessment of the manual handling operation.
- Take steps to reduce the risk of injury to the lowest practicable level.
- Take steps to provide employees undertaking manual handling activities with general information.
- Review the risk assessment if it is no longer valid.
- Review the risk assessment if there is a significant change.

Regulation 5 - Duties of Employees

- Make full and proper use of the safe system of work provided by the employer.

L148 (1st Edition, 2014) – “Safety in Docks”

This approved Code of practice (ACOP) covers **safety** in all dock operations but does have useful references to mooring. This document has effectively replaced the ‘Dock Regulations 1988’.

SIP005 – “Guidance on Mooring”

This guidance document was jointly published by the Health & Safety Executive (HSE) and Port Skills & Safety which along with the ‘L148 - Safety in Docks’ publication replaces the references to mooring from the ‘Dock Regulations 1988). This guide should be read in conjunction with this manual.

Code of Practice for the Safe Mooring of Vessels on the Thames 2016 (as amended)

Although the Port of Tilbury is owned and operated by Forth Ports it is still a requirement for all vessels operating on the River Thames to follow the practices outlined by the Port of London Authority in this code of practice. *This only applies to vessels using river berths and not within the confines of the enclosed dock.*

FORTH PORTS LIMITED	Document ID PoT PMSC OP13/04	Authorised By Deputy HM	Original Date 10/02/16
Mooring Manual	Date Revised Sep 2024	Revised By AMM	Review Due Sept 2027

3. GENERAL SAFETY RULES

3.1 Driving Within The Port

- 3.1.1 Any person who is disqualified from driving on the public roads is also prohibited from driving dock plant and such disqualification should be reported to the Company.
- 3.1.2 Unauthorised passengers riding on any plant, equipment or vehicle is strictly prohibited.
- 3.1.3 Adhere to the port's speed limit at all times.
- 3.1.4 The wearing of seatbelts is compulsory and the use of mobiles when driving is prohibited.
- 3.1.5 Parking enforcement, as indicated by notices or road markings, must be strictly observed.
- 3.1.6 Care you be taken if vehicle occupants are wearing lifejackets inside the vehicle as they can get caught and inflate, causing an accident.
- 3.1.7 Traffic management plans need to be followed and these vary for each berth so make sure you are aware of any traffic management practices in operation for the area of operation.

3.2 Reporting Of Defects

- 3.2.1 It is the responsibility of all employees, contractors or other operators report any defect to plant, vehicles or infrastructure (i.e. Coping, bollards, cranes etc.), and it is the responsibility of supervisors to assess that defect, with engineering assistance if necessary, and ensure its rectification as soon as is reasonably practicable. If necessary mark appropriately to ensure it is not used.
- 3.2.2 Due attention should be paid to the lifebuoys positioned around the quays, and any defects or missing lifebuoys must be reported to the appropriate manager.
- 3.2.3 Similarly defects in quay ladders, fenders, piling etc. must be reported to the appropriate manager for notification to facilities additionally the marine department should be informed.
- 3.2.4 No obstructions should be placed adjacent to quayside bollards preventing safe access for mooring parties. Any such obstructions must be reported to the supervisor for notification to the relevant Manager.
- 3.2.5 Report defective lifejackets immediately to the supervisor in charge of that operation and **DO NOT** use the lifejacket until fixed.

3.3 Signals And Warnings

There are a number of hand signals used for mooring operations and these are shown in Annex 3.

3.4 Safe Working Practices when using Knives

- 3.4.1 Knives, if issued, are for your own safety to prevent injury in the event of a heaving line being caught around you or a colleague's leg or arm. Knives will not easily cut mooring ropes but will easily cut through heaving lines and messenger lines that are caught. If a mooring line needs cutting, an axe may be more suitable.
- 3.4.2 When closing the knife, ensure fingers are clear of the blade housing as you close the blade.
- 3.4.3 Always cut away from or to the side of your body, ensuring limbs are not behind the knife stroke when cutting ropes etc. Ensure fingers are clear of the blade when cutting.

FORTH PORTS LIMITED	Document ID PoT PMSC OP13/04	Authorised By Deputy HM	Original Date 10/02/16
Mooring Manual	Date Revised Sep 2024	Revised By AMM	Review Due Sept 2027

- 3.4.4 Under no circumstances should an open knife be placed in a pocket and when not in use, it must be closed.
- 3.4.5 The knives issued are for work only and should not be taken from the Port and they could be construed as an offensive weapon, *Criminal Justice Act 1988, s 139 (1)*.
- 3.4.6 It is a serious disciplinary offence if any person threatens another person with a knife.

3.5 Emergency Situations

- 3.5.1 Always ensure every member of your team is accounted for at the end of the operation. Anyone missing, whether during the day or night, must be reported and a search started
- 3.5.2 DO NOT TAKE IT FOR GRANTED THAT YOUR COLLEAGUES ARE SAFE. CHECK AND MAKE SURE.**
- 3.5.3 If anyone is missing or there is an accident, make an emergency telephone call immediately using the information below which is also displayed on every lifebuoy station.

PERSON IN THE DOCK	PERSON IN THE RIVER
<p>Call the PORT OF TILBURY POLICE</p> <p>01375 846781</p> <p>&</p> <p>'TILBURY CONTROL' VHF Channel 04.</p>	<p>Dial 999 and ask for the Coastguard / Lifeboat.</p> <p>Call the PORT OF TILBURY POLICE</p> <p>01375 846781</p> <p>&</p> <p>'TILBURY CONTROL' VHF Channel 04.</p>

- 3.5.4 All emergency routes should be kept free from obstruction and properly maintained.
- 3.5.5 Whenever a person is observed to fall into the water anywhere on the port estate, then with all possible haste, witnesses should:
 - Throw the casualty a lifebuoy – found at strategic points around the Port.

FORTH PORTS LIMITED	Document ID PoT PMSC OP13/04	Authorised By Deputy HM	Original Date 10/02/16
Mooring Manual	Date Revised Sep 2024	Revised By AMM	Review Due Sept 2027

- Follow the procedures set out in section 3.5.3.
- Alert the Lockside, who in turn will alert PLA. (if outside the dock)
- Keep a close watch on the casualty, enrolling others to help to do the same.
- **DO NOT** enter the water to affect a rescue.

3.5.6 Usually the Port of Tilbury police will liaise with the emergency services but should you need to speak to the emergency services, ensure that clear and precise instructions are given to the emergency services and that someone is available to meet and guide them to scene although this is typically done by the police. Remain available on the phone to answer any questions.

It is important to give as much information to the emergency services so they can plan ahead for the rescue and give any further advice over the phone.

3.5.7 Internal reporting procedures should be followed in the event of any incident. Typically, this would be through the marine department if it involves mooring operations, but some assets may have their own procedures where duty managers also need to be informed.

3.5.8 All lifesaving equipment should be kept in good order and any defect observed should be reported.

3.6 Alcohol and Drugs

3.6.1 Port of Tilbury employees are required to follow the port's alcohol and drugs policy at all times.

3.6.2 External contractors and anyone else involved in the mooring operation will have their own internal policies to follow, but must adhere to the following points when working within the Port of Tilbury:

3.6.2.1 The consumption or being under the influence of alcohol or drugs whilst on duty is forbidden.

3.6.2.2 Any person reporting for duty having consumed alcohol or drugs and who in the opinion of Management or any responsible person is considered to be a possible danger to themselves or other persons whilst at work will not be allowed to commence or continue duty.

3.6.2.3 Persons under medication that may affect their judgement are required to inform Management of the circumstances before starting work.

3.7 Hazard Awareness

3.7.1 The mooring team must be aware of the hazards associated with the tasks and be familiar with the risk assessments for that task.

3.7.2 During the mooring operation the mooring crew need to be aware of the ship movement, the ships lines (ropes) and the condition of the tide.

3.8 Person in the Water – Hyperthermia

3.8.1 Following the initial immersion of 2 to 3 minutes there would be a cold shock reaction resulting in an increase in heart rate and blood pressure. This would be followed by rapid exhaustion over a period of 2 to 15 minutes.

FORTH PORTS LIMITED	Document ID PoT PMSC OP13/04	Authorised By Deputy HM	Original Date 10/02/16
Mooring Manual	Date Revised Sep 2024	Revised By AMM	Review Due Sept 2027

- 3.8.2 A long-term immersion (15 minutes plus) could result in the body core temperature falling below 36.9 degrees centigrade. Hypothermia would kick in at about 35 degrees centigrade. Heart failure will occur around 24 degrees centigrade.
- 3.8.3 The water temperature plus the immersion time will dictate the end result. Obviously the water temperature will differ throughout the year with winter usually being the coldest time.
- 3.8.4 Casualties can be recovered from the water using the escape ladders positioned along the berths. Lifebuoys are positioned at regular intervals along the berths and can be used to assist in recovery.
- 3.8.5 It is good practice to familiarise yourself with emergency equipment prior to commencement of the operation.



FORTH PORTS LIMITED	Document ID PoT PMSC OP13/04	Authorised By Deputy HM	Original Date 10/02/16
Mooring Manual	Date Revised Sep 2024	Revised By AMM	Review Due Sept 2027

4. LIFE JACKETS & OTHER PERSONAL PROTECTIVE EQUIPMENT

1.2 4.1 GENERAL INFORMATION ON PERSONAL PROTECTIVE EQUIPMENT.

- 4.1.1 Those of which this manual applies must wear a lifejacket whenever they are working within 3m of the quay edge or while boarding, disembarking or operating vessels.
- 4.1.2 Failure to wear a lifejacket at the appropriate time is a disciplinary offence and external mooring contractors will have their licence to operate within the port withdrawn. As it is part of your personal protective equipment you are personally responsible for it.

4.2 Personal Protective Equipment (PPE) for mooring

- 4.1.3 Any PPE issued by the port or contracting company should be worn for the purpose it was intended for and should be worn correctly as per the manufacturers guidance.
- 4.1.4 For mooring operations there are many dangers and hazards which can be minimised by the wearing the correct PPE as shown below:



- 4.1.5 Safety Helmets must be worn with chin straps and on all quays and jetties. They should be replaced if:
 - Following severe impact
 - When scratches amount to 25% of the shell thickness.
 - When cracking is evident.
 - If they exceed 2 years from issue.

FORTH PORTS LIMITED	Document ID PoT PMSC OP13/04	Authorised By Deputy HM	Original Date 10/02/16
Mooring Manual	Date Revised Sep 2024	Revised By AMM	Review Due Sept 2027



- 4.1.5 High Visibility clothing must be worn in **ALL** working areas.
- 4.1.6 Gloves are worn to protect the hands from sprags, splinters and sharp edges. Wearing gloves also helps protect the user from waterborne diseases, such as, hepatitis and leptospirosis.
- 4.1.7 Safety boots/shoes must be worn at all times whilst in operational areas. This includes work on all quaysides.
- 4.1.8 All personnel, whenever they are within operational areas, must wear the high visibility clothing and safety footwear provided. In addition, safety helmets and lifejackets must be worn in designated areas.
- 4.1.9 Shorts are permitted to be worn during mooring operations. (Refer to local operation's RAMS)

4.2 Lifejacket checks and inspection

- 4.2.1 The following are recommendations made to the marine industry by the MCA as regards to the safe use of inflatable lifejackets. It is intended to reduce the likelihood of lifejackets failing to inflate in an emergency.

SERVICE Lifejackets must be serviced at regular intervals as specified by the risk assessment for that operation. Lifejackets should be regularly serviced although any faults, damage or other issues should be raised immediately by the individual in order that it can be rectified at the earliest opportunity.

INSPECT Inspect your lifejacket before donning every time you use it using the following checklist.

	<p>Check the general condition of the outer cover ensuring there are no tears or other damage.</p>
	<p>Check that the buckles are in good condition and fit for purpose.</p>

FORTH PORTS LIMITED	Document ID PoT PMSC OP13/04	Authorised By Deputy HM	Original Date 10/02/16
Mooring Manual	Date Revised Sep 2024	Revised By AMM	Review Due Sept 2027



Check straps are not worn or have any damage to them. Stitching must be intact.



If the lifejacket is fitted with a service sticker, ensure it is in date and return any over due jackets for servicing. These service stickers vary in location.

Typical practice is that the next service is given rather than the last.



Check that all velcro seems are fully attached and not left open. Any dirt or water that gets inside the casing can cause the inner bladder to become damaged and not inflate when required.



Ensure the fitted gas cylinder is not corroded and hand tight in the connector.

FORTH PORTS LIMITED	Document ID PoT PMSC OP13/04	Authorised By Deputy HM	Original Date 10/02/16
Mooring Manual	Date Revised Sep 2024	Revised By AMM	Review Due Sept 2027

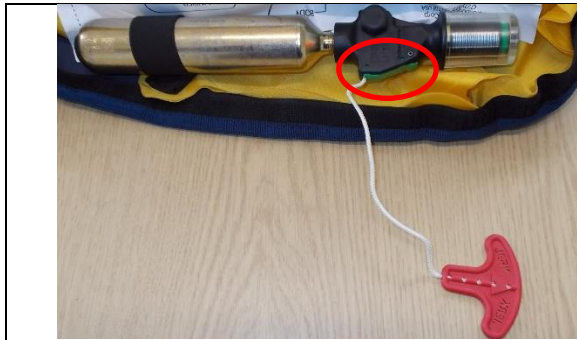

The indicator clip should be green.



The bobbin should be green.

REPORT ANY DEFECTS OR DAMAGE TO THE APPROPRIATE SUPERVISOR, AS WELL AS ANY ACCIDENTAL INFLATIONS.

FOLLOW Always follow the manufacturer's care, stowage and donning instructions at all times.

4.3 Donning your lifejacket

- 4.3.1 Having inspected your lifejacket as instructed above, it is important to don your lifejacket in accordance with the manufacturer's instructions.
- 4.3.2 Straps should be secured around the waist as high as comfortably possible and your crotch strap secured tight enough to prevent the lifejacket riding up and over your head in the event of entering the water.
- 4.3.3 The manual red pull cord should be outside the lifejacket as shown, to ensure it is accessible in the event of entering the water and the jacket does not automatically inflate.
- 4.3.4 Crotch straps must be worn at all times.



REMEMBER YOUR LIFEJACKET COULD SAVE YOUR LIFE SO TREAT IT WITH CARE AND STORE IN A SECURE AND SAFE MANNER.

FORTH PORTS LIMITED	Document ID PoT PMSC OP13/04	Authorised By Deputy HM	Original Date 10/02/16
Mooring Manual	Date Revised Sep 2024	Revised By AMM	Review Due Sept 2027

4.4 Storing your lifejacket

4.4.1 Lifejackets should always be dry before storage and protected when ever possible in the protective cases they came in.

5. MOORING

5.1 BEFORE SHIP'S ARRIVAL

Prior to the arrival of a ship, there will be location specific activities to ensure safe and effective mooring operations take place. These include but are not limited to the following:

(local or asset specific information is included in the annexes in this manual).

- Mooring plans
- Cargo plans
- Berth allocations
- Berth plans (e.g. where cranes will be positioned).

5.2 COMMENCEMENT OF MOORING OPERATION

5.2.1 Personnel should make themselves available promptly on the quayside as the vessel berths and not wait until the last possible moment. This indicates to the vessel's crew that the mooring crew are ready to assist. At the same time the mooring personnel should inspect the quay to ensure that the area is safe to work.

5.2.2 Contact should be established between the mooring supervisor/berthing Master and the ship's Master/Pilot. Final mooring arrangement to be agreed.

5.3 HAZARDS DURING THE MOORING OPERATION

5.3.1 Beware of heaving lines being thrown or projected across the dock which may include a weighted tail end consisting of a 'monkey's fist' or other suitably weighted object.

**WEAR YOUR SAFETY HELMET
STAY ALERT AT ALL TIMES**

5.3.2 If the heaving line is thrown and the weighted end is deemed to be of a dangerous weight, it should be cut off and confiscated with a full report given to the marine department who can take action against the vessel.

5.3.3 When receiving mooring ropes or heaving lines, stand at a suitable distance from the quay edge so that you can safely see the vessel's crew.

5.3.4 As mooring ropes are heaved ashore, ensure sufficient rope is heaved onto the quay before dragging towards the bollard to reduce the amount of weight being hauled.

**MOORING TEAMS SHOULD ONLY EVER ACCEPT ONE MOORING ROPE AT A TIME.
MOORING ROPES ARE HEAVY ESPECIALLY WHEN WET.**

FORTH PORTS LIMITED	Document ID PoT PMSC OP13/04	Authorised By Deputy HM	Original Date 10/02/16
Mooring Manual	Date Revised Sep 2024	Revised By AMM	Review Due Sept 2027

- 5.3.5 Be aware of worn ropes and report any defects straight away to the supervisor, so that the marine department can be later informed. A worn rope is more likely to part when under load.



Rope in good condition



Rope in bad condition

5.3.6 .

- 5.3.7 When accepting a mooring rope, beware of the vessel paying out additional line too quickly, which adds extra weight to the mooring rope already being heaved ashore, or could suddenly drag the mooring team unexpectedly towards the quay edge.
- 5.3.8 Ensure that when hauling ropes ashore you are not walking into danger. **BE AWARE** of what is around you.
- 5.3.9 If an excessive load comes onto the rope as it is being handled, **LET IT GO, DO NOT ATTEMPT TO HOLD IT BACK.** Warn all team members immediately of the need to let go the mooring rope in unison.
- 5.3.10 Should any line become sucked into the thrusters or the ship's propeller(s), tension will come on very quickly and the line should be immediately dropped to prevent any personnel being dragged into the water.
- 5.3.11 **NEVER** hold any rope by the crown of the eye when placing the eye on a bollard or hook, always hold the rope by the side of the eye or the standing part and throw the eye over the bollard or hook. Never let your hand or fingers get between the rope and the bollard. (see picture right)
- 5.3.12 When the eye of the rope has been placed on the bollard, tell the person(s) holding the weight to "let go". Ensure messenger / tail and heaving lines are clear of working area near bollard.
- 5.3.13 **NEVER** allow yourself or others to get trapped between a rope and a fixed object.
- 5.3.14 **NEVER** stand in or allow others to stand in a loop or 'bight' of any rope.



FORTH PORTS LIMITED	Document ID PoT PMSC OP13/04	Authorised By Deputy HM	Original Date 10/02/16
Mooring Manual	Date Revised Sep 2024	Revised By AMM	Review Due Sept 2027

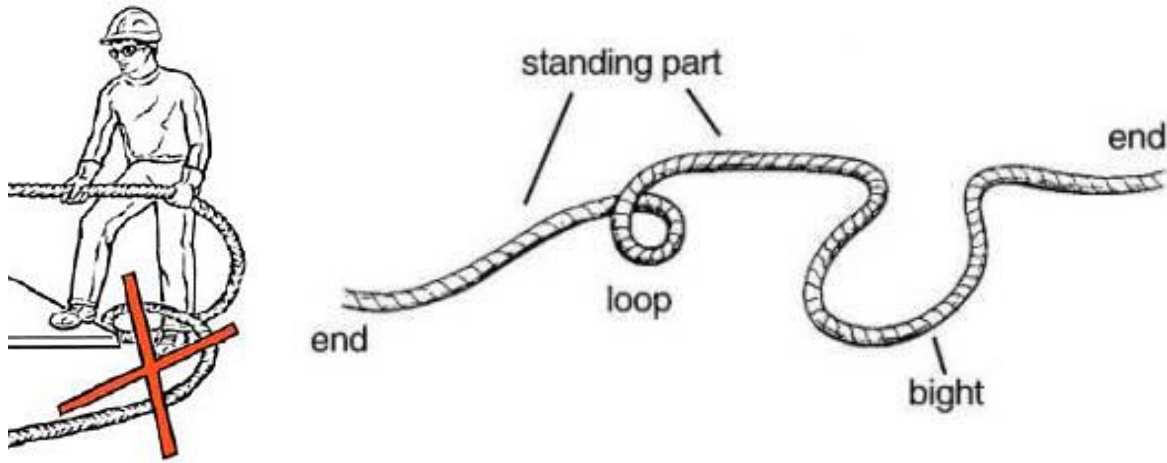

5.3.15 Once a mooring rope has been placed on the bollard, keep well clear while the ship heaves the line taught. Be aware that, should the line part, it can whiplash anywhere across the dock causing severe injury or even death.

5.3.16 Sudden tension applied to a rope either by the ship's winch and/or movement of the ship by surging or listing can cause the rope to snake without parting. Anyone in the near vicinity i.e. putting another rope on the same bollard, can be dealt a severe blow.



5.3.17 Wire ropes are notorious for spragging, (see image right) where broken fibres protrude out along the wire rope but in particular, areas susceptible to the most spragging occurs at the eye and at the splice. These sprags can inflict injuries and can even penetrate gloves.



5.3.18 Never let a wire rope slide through your hand and never slide your hand along the rope. **DO NOT WEAR RINGS**. Rings being caught in sprags have caused serious hand injuries. Any badly stranded or rusted rope should be refused. Notify the Berthing Master or Marine operative who will inform the ship's deck officer.

5.4 BOLLARD TYPES

5.4.1	<p>TEE BOLLARDS These are small but capable of withstanding large loads. They can only take one or two mooring lines at any one time. Usually cast into the quay.</p>	
-------	---	--

FORTH PORTS LIMITED	Document ID PoT PMSC OP13/04	Authorised By Deputy HM	Original Date 10/02/16
Mooring Manual	Date Revised Sep 2024	Revised By AMM	Review Due Sept 2027

5.4.2	<p>HORN BOLLARDS Capable of taking multiple mooring lines and allows for a steep angle of line towards the ship.</p>	
5.4.3	<p>Single Bitt Bollard Capable of taking multiple ropes. A slip is often included to prevent lines slipping off. Due care is needed with steep lines, so that they don't come off when heaved tight. Additional turns round the bollard may sometime minimise the chance of this.</p>	

5.5 BOLLARD PRACTICES

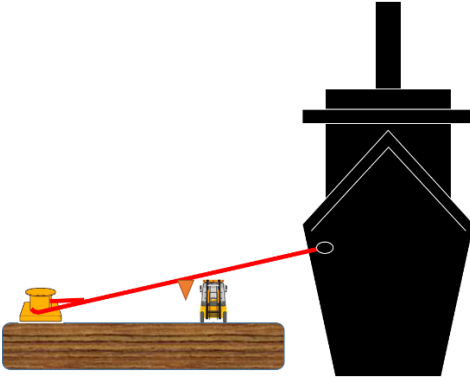
5.5.1	<p>INSET BOLLARDS are also called storm bollards, which are set a way into the quay to increase their pull capacity. These are found on the Landing Stage and at LCT where they are used to hold ships alongside during high winds. They can also be used for normal mooring practices.</p> <p>Care should be taken when doing this particularly if there is to be traffic moving under the lines. If this is the case a flag or another suitable marker should be placed on the line to warn drivers of the height restriction. As shown below.</p> 
-------	--

FORTH PORTS LIMITED	Document ID PoT PMSC OP13/04	Authorised By Deputy HM	Original Date 10/02/16
Mooring Manual	Date Revised Sep 2024	Revised By AMM	Review Due Sept 2027



ALL PERSONNEL OPERATING IN THE AREA OF MOORING ROPES SHOULD BE AWARE OF THE ASSOCIATED DANGERS

5.5.2	<p>If only one mooring rope is to be placed on the bollard, then the 'standard' or 'Fully Cocked' configuration can be used</p>	
5.5.3	<p>If there is another ship to berth on an adjacent berth requiring to use the same bollard then lines should be half cocked.</p>	
5.5.4	<p>If needed 'dip' the second line when placing the eye of a second mooring line over a bollard. The eye of the second line is brought up through the eye of the first line. This prevents the lines becoming jammed and helps with the release of the line.</p> <p><i>The following page shows the procedure for dipping a line correctly.</i></p>	

FORTH PORTS LIMITED	Document ID PoT PMSC OP13/04	Authorised By Deputy HM	Original Date 10/02/16
Mooring Manual	Date Revised Sep 2024	Revised By AMM	Review Due Sept 2027

The linesman is dipping the eye of a head line through the eye of a head line already secured to the bollard, so that either line can be easily let go first.

This is sometimes called a '**Schieman Knot**'.

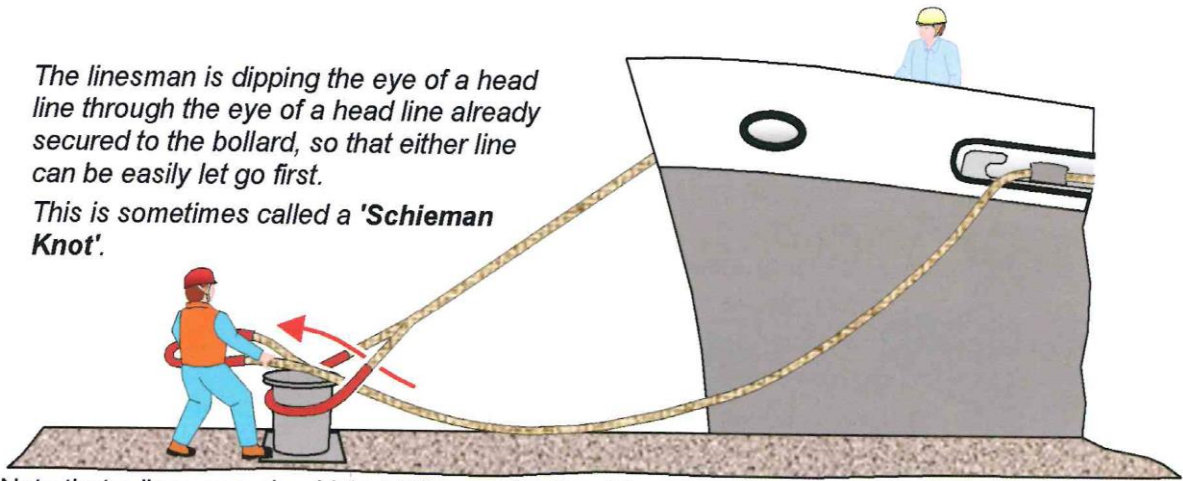

Note that a linesman should **hold the eye by its side**, rather than the crown, when putting it over the bollard to avoid his hands being trapped between the eye and the bollard if the line comes tight.

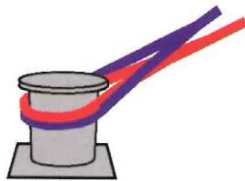

— = 1st mooring line, — = 2nd mooring line

Dipping successive lines through the eyes of lines already secure on the bollard allows any line to let go first, **provided that the lines all lead in approximately the same direction**. However, this does not necessarily work when the lines lead in different directions, as shown below.

The effect of dipping the eye when the lines lead in very different directions

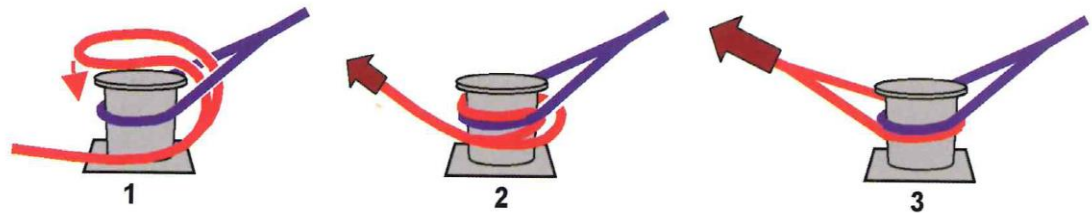

- 1 - The red line from a ship is dipped through the eye of the blue line from a ship on the next berth.
 - 2 - As the red line is hauled in, so the eye is pulled around and nipped under the blue line.
 - 3 - Heaving the red line tight forces the blue eye to ride over the red eye and push it to the bottom.
- The red line can slip under the blue one in this situation, especially when one line goes slack whilst the other tightens with the changes in the tide, so dipping the red line will not guarantee that it can be **easily** released before the blue line. However, the bottom line can be cleared, as shown below:-

Freeing a bottom eye from a bollard without letting go the line above

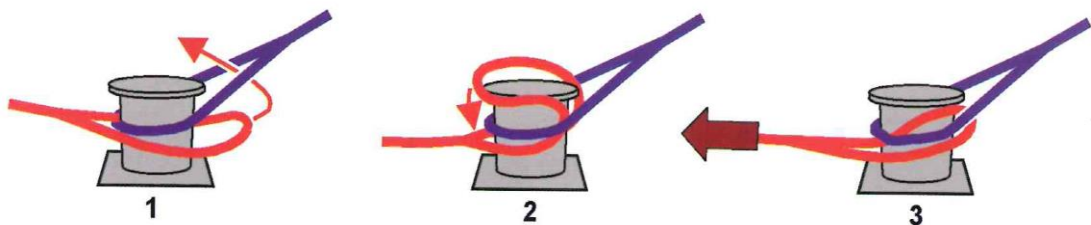

- 1 - The bottom red line is slacked off so that the red eye can be passed up through the blue eye.
 - 2 - The red eye is looped back over the bollard to release it from the bollard.
 - 3 - The blue eye now entraps a bight of the red eye that can either be pulled or worked totally free.
- It is possible that a bottom eye will be trapped if the lines above it are very tight but it will normally come free with a **light tug** on the ship's mooring winch.

Fig. 2.11 Dipping a mooring line when putting the eye over a quayside bollard

Mooring Manual	P01 PMSC OP15/04	Deputy HM	10/02/10
	Date Revised Sep 2024	Revised By AMM	Review Due Sept 2027

5.6 MOORING ROPE IDENTIFICATION

5.6.1 The lines are defined as follows:

- Breast Lines: - Used to hold the vessel alongside the quay wall.
- Head and Stern Lines: - Used to hold the vessel alongside and control its longitude position.
- Springs: - Usually the first lines sent ashore and the last 'let go'. They prevent the vessel 'ranging' (moving ahead and astern) along the quay wall.



A	Stern line	D	Forward Spring
B	Breast line	E	Breast line
C	Aft Spring	F	Head line

5.6.2 Different types of ropes give different alarm signals.

- Sisals, manilas or coir will creak and squeak.
- Terylene, terylene-cotton, polypropylene or any of the man-made fibres will creak.
- Wire rope will "sing" or crack.
- Nylon may make no noise at all, except for a very loud crack when it parts.

Beware of any such noises and keep away.

5.6.3 New materials are continually being introduced therefore, care should be taken when handling any ropes.

5.6.4 Ensure that all ropes are snug on the bollards or hooks, and that they do not become foul of sharp edges, fenders or equipment on the quayside.

5.6.5 When using sunken bollards, that are normally covered when not in use. Move the cover plates to a safe position and place warning cones on plates to mark them.

FORTH PORTS LIMITED	Document ID PoT PMSC OP13/04	Authorised By Deputy HM	Original Date 10/02/16
Mooring Manual	Date Revised Sep 2024	Revised By AMM	Review Due Sept 2027

- 5.6.6 On completion of mooring ensure that heaving lines, messengers etc. are returned to the ship and that all is secure.
- 5.6.7 Mooring vehicles to tow mooring ropes:-
- 5.6.7.1 The use of vehicles during mooring operations will **ALWAYS** be at the discretion of the supervisor. Approval to use vehicles must be sought **BEFORE** the operation commences. The fixed eye or bight of a mooring rope or wire should **NEVER** be secured directly to the towing pin. Using a figure of eight pattern around the pin and ensuring that at any time this can be quickly released. The rope tail should be held by a person standing to landward side as the vehicle is driven slowly along the quay, keep an eye on both the rope and driver at all times.
- 5.6.7.2 Should there be any reason to let this rope tail go, the rope should be slipped, and this is why the mooring party should also be standing well clear during this practice.
- 5.6.7.3 Sufficient slack rope or wire should be flaked on the quay to allow the eye to be taken to the required bollard without strain.
- 5.6.8 On completion of the mooring operation report to the supervisor.

FORTH PORTS LIMITED	Document ID PoT PMSC OP13/04	Authorised By Deputy HM	Original Date 10/02/16
Mooring Manual	Date Revised Sep 2024	Revised By AMM	Review Due Sept 2027

6. UNMOORING SHIPS

- 6.1 Mooring teams, when attending vessels that are about to depart, must not let go of the moorings until authorised to do so by the supervisor.
- 6.2 The supervisor should make a visual check of the quay to ensure there are no obstructions for the ship's departure, such as, crane booms being down or gangways still extending outside the ship's rail. Although this will have been done on the ship's arrival, there is always a chance that new obstructions will have developed while the ship is alongside.
- 6.3 Stand clear of bollards when waiting. Do not sit on the bollard or the quay edge. Be alert to what the ship's crew are doing and what your colleagues are doing.
- 6.4 Go to the bollard or hook only when the rope to be released is slack, release the rope, ensure the messenger/tail is clear, and then stand well clear. Then indicate to the vessel's crew that the rope is clear and that they can heave away.

i. **DO NOT STAND NEAR THE BOLLARD OR HOOK**

- ii. Repeat the procedure for every rope.

- 6.5 When a ship is "singled up" and making ready to haul off, extra strain will be put on the ropes when "springing off" i.e. to spring off the head will require heaving in on a stern line which will place extra strain on the "spring". If the stern is to be sprung off the strain will be placed on the head rope and back spring.
 - iii. Invariably when a ship is "springing off" the ship will be using its engine and propeller(s) to obtain extra leverage; this could mean extra strain on the rope(s).

If tugs are used to pull the ship off, then greater strain may be placed on the rope(s) even if the tug is only taking sufficient strain to hold itself in position.

- 6.6 Wind off the land will increase the load on a mooring rope, particularly on a large ship with deck cargo.
- 6.7 When releasing any rope from a bollard, the rope has to be grasped by the side of the eye. Never slide your hand along the rope and never let your hands or fingers get between the rope and the bollard.
- 6.8 When releasing a dipped rope always pull sufficient slack through the eye or eyes of the other rope(s) and then turn the dipped eye over the bollard. If it is jammed by one of the other ropes, pull the clear part right over the top of the bollard so that it can be pulled free, then signal to the crew to haul it free, making sure the messenger line is clear and you must stand well clear of bollard until the rope is free.
- 6.9 When the vessel and ropes are clear, report this to the supervisor.
- 6.10 Do not leave the berth until you have been instructed to do so by the supervisor and only when you are certain that the vessel is clear and underway. On rare occasions vessel's may want to proceed back alongside due to technical issues or other emergency matters.

FORTH PORTS LIMITED	Document ID PoT PMSC OP13/04	Authorised By Deputy HM	Original Date 10/02/16
Mooring Manual	Date Revised Sep 2024	Revised By AMM	Review Due Sept 2027

7. USE OF CAPSTANS

7.1 Upon Arrival to Site

- 7.1.1 Mooring/unmooring crews should arrive early and in good time prior to a vessel departure or arrival.
- 7.1.2 By arriving early and in good time, this will enable you to make the necessary pre operational checks.
- 7.1.3 Always use the access and egress points provided.
- 7.1.4 Always park vehicles in approved and authorised places.
- 7.1.5 Operatives must wear the correct PPE as detailed in the risk assessment and the safe systems of work.
- 7.1.6 PPE should be checked prior to use.
- 7.1.7 Always attend the pre works briefing.
- 7.1.8 It is advisable to check any weather warnings prior to undertaking any mooring/unmooring activities.
- 7.1.9 All personnel who carry radios, must ensure that these have been checked and are in working order.

7.2 Pre-Operational Checks of the Worksite

- 7.2.1 Access ways and ladders must be visually checked prior to use.
- 7.2.2 A full visual inspection of the dolphins must be carried out.
- 7.2.3 Safety chains across open ladders must be clipped on, when not in use.
- 7.2.4 All life buoys must be visually checked.
- 7.2.5 Top, intermediate, and bull bar rails must be visually checked to ensure they remain secure.
- 7.2.6 The area on the dolphin should be clean and clear of debris, with free, unobstructed access.
- 7.2.7 Lighting must be checked prior to undertaking any mooring or unmooring duties.
- 7.2.8 In low lighting, the lights on the dolphins should be switched on (if required).
- 7.2.9 If you experience any issues, difficulties or concerns, report them immediately to the supervisor.

7.3 Pre-Use Capstan Checks

- 7.3.1 Only trained and competent persons are permitted to use and operate the capstans.
- 7.3.2 Operatives should always work in pairs as a minimum. Agree who is going to operate the capstan prior to the operation.
- 7.3.3 Ensure that the capstan's power is switched off.
- 7.3.4 Make a visual check of the entire unit for signs of damage, distortion, cracks or corrosion. If found, do not use the capstan and report any issues or concerns immediately to the

FORTH PORTS LIMITED	Document ID PoT PMSC OP13/04	Authorised By Deputy HM	Original Date 10/02/16
Mooring Manual	Date Revised Sep 2024	Revised By AMM	Review Due Sept 2027

supervisor.

- 7.3.5 Make a visual check of the anchor bolts and ensure that there are no damage or loose bolts.
- 7.3.6 Make a visual check of the rubber impact block (where fitted) for signs of wear and damage.
- 7.3.7 Make a visual check of the control box for any signs of damage.
- 7.3.8 Make a visual check of power cables for any signs of damage, frayed or loose connections.
- 7.3.9 Position footswitch out of reaching distance from the rotating drum. Approx. 1m away.
- 7.3.10 Make a visual check of the footswitch cable for any damage, frayed or loose connections.
- 7.3.11 Turn power on.
- 7.3.12 Select clockwise or anti-clockwise rotation using the selector switch and test the capstan motor by pressing the footswitch.
- 7.3.13 Repeat the process by selecting the opposite direction.
- 7.3.14 The capstan motor must be tested in both directions for at least 30 seconds.
- 7.3.15 Confirm that the capstan drum rotates smoothly with no dragging, wobbling or binding.
- 7.3.16 Confirm that there is no audible crunching, grinding or visual indications of electrical or mechanical malfunction.
- 7.3.17 Test the emergency stop button, while the capstan is rotating, the other operative should engage the e-stop.
- 7.3.18 If the capstan fails to stop under the emergency test, turn the capstan off and do not use the machine. Report this immediately to the supervisor.
- 7.3.19 Re-set the emergency stop button by twisting and releasing it back into position.
- 7.3.20 Make a visual check to ensure that the slip hooks are in the closed position.
- 7.3.21 Check each slip hook by releasing them utilising the bar lever.
- 7.3.22 If the slip hooks are open, close them manually by swinging them back into the working position.

7.4 Operating the Capstan

- 7.4.1 Ensure that the hook to receive the mooring line is closed and secure.
- 7.4.2 Set the required directional rotation using the selector switch.
- 7.4.3 Pass the messenger line through the rope guard (where fitted).
- 7.4.4 Apply three or four non-overlapping turns of the messenger line onto the capstan drum. When doing this, the capstan drum must be stationary. Under no circumstances apply the messenger line while the capstan is rotating or in operation.
- 7.4.5 Take hold of the messenger line approximately a 1m away from the drum.

FORTH PORTS LIMITED	Document ID PoT PMSC OP13/04	Authorised By Deputy HM	Original Date 10/02/16
Mooring Manual	Date Revised Sep 2024	Revised By AMM	Review Due Sept 2027

- 7.4.6 Start the capstan by pressing the foot pedal switch.
- 7.4.7 At the same time, apply a smooth progressive pull until the messenger line grips the capstan head firmly. (Note: If the capstan is overloaded, the overload protector will trigger).
- 7.4.8 Ensure that the excessive messenger line is coiled neatly to the dolphin surface to avoid potential 'bites'.
- 7.4.9 All other personnel must stand away from the rotating drum while the capstan is in operation.
- 7.4.10 When the mooring line is sufficiently close to the hook, stop the capstan motor by releasing the pressure on the foot pedal.
- 7.4.11 Bring the capstan to a stop.
- 7.4.12 Select the opposite directional rotation using the selector switch.
- 7.4.13 Start the capstan by pressing the foot pedal.
- 7.4.14 Slowly allow the messenger line to feedback to the capstan, resulting in the mooring rope dropping back towards the hook.
- 7.4.15 Bring the capstan to a stop.
- 7.4.16 Place the eye of the mooring line over the hook.
- 7.4.17 Once the mooring line is secured, release the remainder of the messenger line from the capstan drum.
- 7.4.18 Turn off the capstan power

8. USE OF HOOKS

8.1 Manual Hook Release

The procedure for manually releasing hooks is as follows:

- 8.1.1 Insert the manual release lever Fig 1 into the release lever tube – refer to Fig 2

Fig 1 - Lever



FORTH PORTS LIMITED	Document ID PoT PMSC OP13/04	Authorised By Deputy HM	Original Date 10/02/16
Mooring Manual	Date Revised Sep 2024	Revised By AMM	Review Due Sept 2027

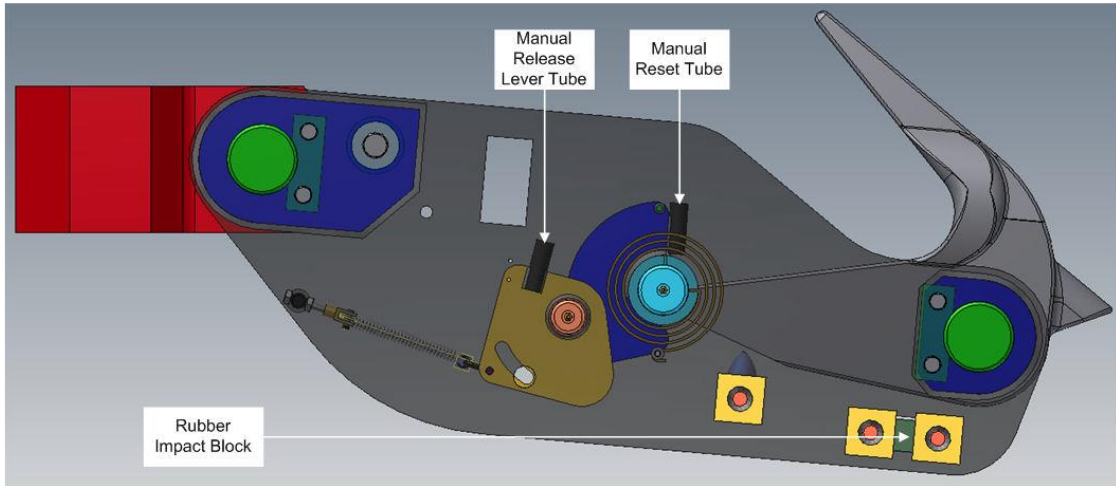

Fig2 - View of a hook showing the manual release components.



Fig 3 - Release Tube

- 8.1.1.1 Pull the manual release lever backwards fig 4. The hook should then open. **Note.** If the load on the hook is approximately 5 tonnes or greater when it is released, fig 5, then the impact of the hook on the shock-absorbing elastomeric (rubber) impact block will automatically return the hook to the closed position.

FORTH PORTS LIMITED	Document ID PoT PMSC OP13/04	Authorised By Deputy HM	Original Date 10/02/16
Mooring Manual	Date Revised Sep 2024	Revised By AMM	Review Due Sept 2027



Fig 4 Release Position push back



Fig 5 Hook in open position

- 8.1.1.1.1 If the hook does not self-close when the line is released, close the hook as described in closing hooks – in the next section.

8.2 Closing Hooks

- 8.2.1 Ensure that the manual release lever is not engaged. Swing the hook manually back into the closed position. The reset spring will cause the release mechanism to automatically close and lock.

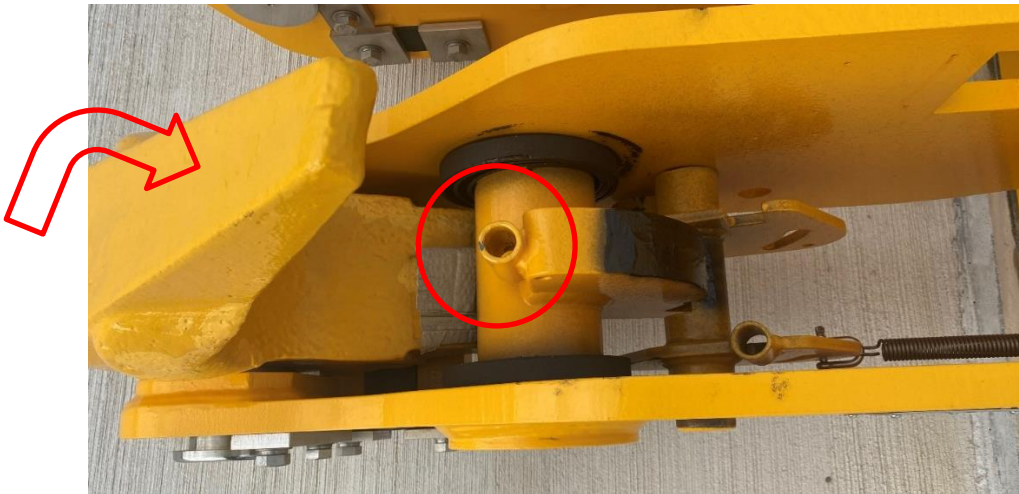

Fig 6 Reset tube and hook in reset position

- 8.2.2 If the release mechanism does not close and lock, set the hook in the closed position, Fig 6, insert the manual release lever into the manual reset tube, Fig 7 – refer to Fig 2 – and swing the hook pawl into the closed position. Ensure that the hook is locked and then remove and stow the manual release lever. If the release mechanism does not close and lock report it.

FORTH PORTS LIMITED	Document ID PoT PMSC OP13/04	Authorised By Deputy HM	Original Date 10/02/16
Mooring Manual	Date Revised Sep 2024	Revised By AMM	Review Due Sept 2027



Fig 7 Lever in reset tube pushed forward to lock

Check the hook manual release and hook closure operations

The operation of the hook manual release and locking mechanism should be checked to ensure that all components are serviceable and free to move.

Caution: After a hook has been released it should be returned to the closed position, as soon as, possible to prolong the life of the reset spring.

The following procedure should be performed for each of the unused hooks in the mooring unit.

- 1 Insert the release lever into the release lever tube – refer to Fig 2.
- 2 Pull the release lever backwards and check that the hook releases smoothly with no dragging or binding. If any problem is noted this should be reported immediately so that the problem can be investigated and the appropriate corrective action completed.
- 3 Remove the manual release lever and swing the hook manually back into the closed position. Confirm that the release mechanism automatically closes and locks the hook.
- 4 If the release mechanism does not close and lock, set the hook in the closed position, insert the manual release lever into the manual reset tube – refer to Fig 2 and swing the hook pawl into the closed position. Ensure that the hook is locked and then remove and stow the manual release lever. Report the failure to close so that the problem can be investigated and the appropriate remedial action completed.

FORTH PORTS LIMITED	Document ID PoT PMSC OP13/04	Authorised By Deputy HM	Original Date 10/02/16
Mooring Manual	Date Revised Sep 2024	Revised By AMM	Review Due Sept 2027

Hook

Manual Release

Rope Guide

Capstan Head

Lever Reset

FootSwitch

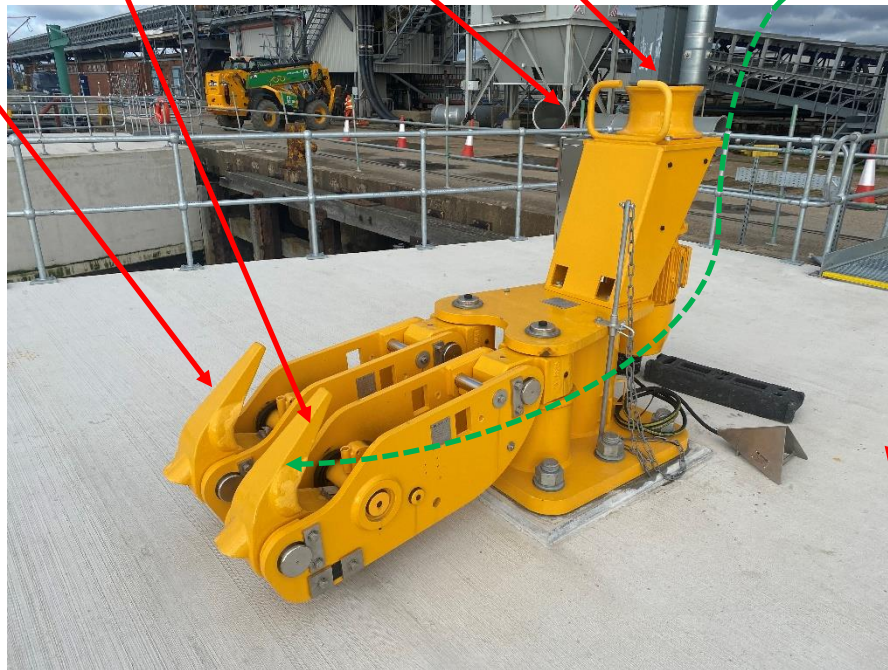

FORTH PORTS LIMITED	Document ID PoT PMSC OP13/04	Authorised By Deputy HM	Original Date 10/02/16
Mooring Manual	Date Revised Sep 2024	Revised By AMM	Review Due Sept 2027

9. COMMUNICATIONS & MANPOWER

9.1 Radios

- 9.1.1 At least one radio should be carried within the mooring team at all times by the supervisor so that they can liaise with the Master and/or Pilot.
- 9.1.2 The working channel should be agreed in advance between all parties especially if tugs are being used.
- 9.1.3 When using a radio, ensure your message is transmitted cleanly by pressing the transmit button for 2 seconds before you start talking.









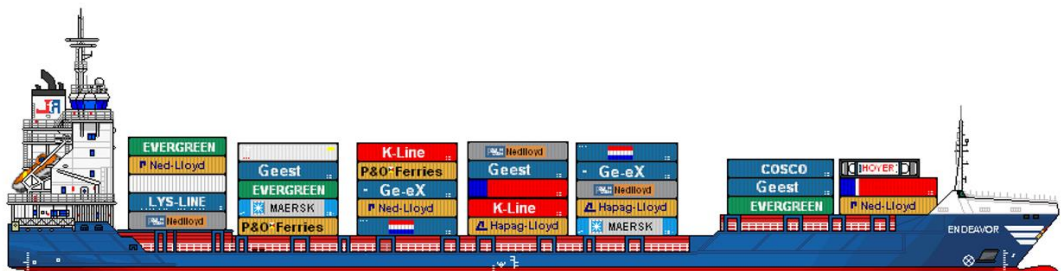









9.2 Roles and Responsibilities

During the mooring operation there should always be a dedicated supervisor who is responsible for liaising with the ship's Master and/or Pilot, as well as being able to give additional orders to the rest of the mooring team. Normally the supervisor will not be involved with heaving lines or physically mooring the ship. Exception to this is in the lock where fewer lines are used.

9.3 Recommended size for mooring teams

The following diagrams illustrate the recommended number of personnel required for each operation. Specific operations such as lockside will differ and are identified in the relevant port risk assessment.



	MAKING FAST			LETTING GO		
	AFT	BRIDGE POSITION	FWD	AFT	BRIDGE POSITION	FWD
0 to 122m	 2 MEN TEAM	 1 SUPERVISOR	 2 MEN TEAM	 1 MAN TEAM	 1 SUPERVISOR	 1 MAN TEAM
122m to 183m	 3 MEN TEAM	 1 SUPERVISOR	 3 MEN TEAM	 2 MEN TEAM	 1 SUPERVISOR	 2 MEN TEAM
183 or greater	 4 MEN TEAM	 1 SUPERVISOR	 4 MEN TEAM	 2 MEN TEAM	 1 SUPERVISOR	 2 MEN TEAM

FORTH PORTS LIMITED	Document ID PoT PMSC OP13/04	Authorised By Deputy HM	Original Date 10/02/16
Mooring Manual	Date Revised Sep 2024	Revised By AMM	Review Due Sept 2027

AFT LINESMEN TEAM

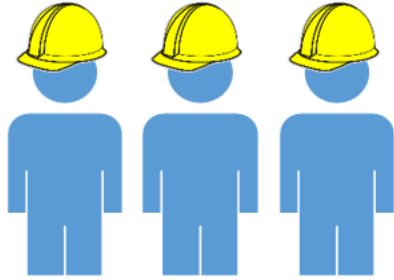

SUPERVISOR



FORWARD LINESMEN TEAM

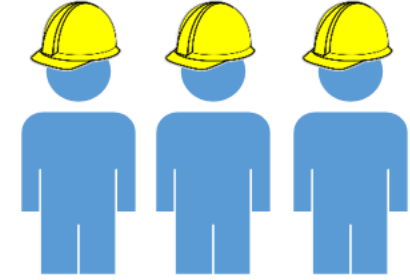

On some ships instructions may come from the ship's crew so some communication using voice or hand signals may be required.



The supervisor will liaise, by radio, with the Master and/or pilot on the bridge when the vessel is approaching to confirm position.



On some ships instructions may come from the ship's crew so some communication using voice or hand signals may be required.

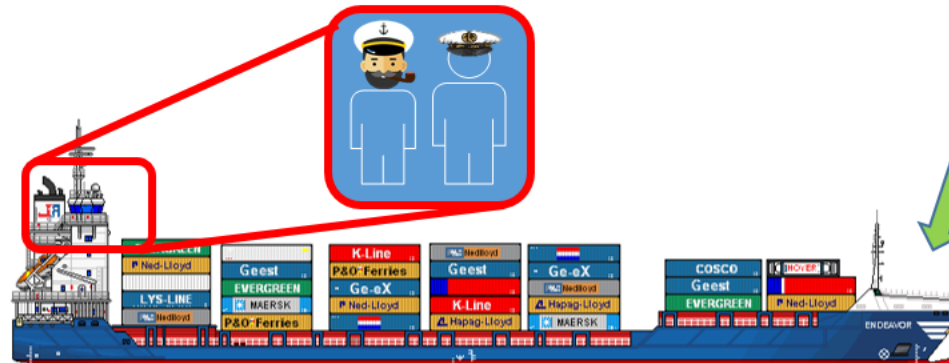
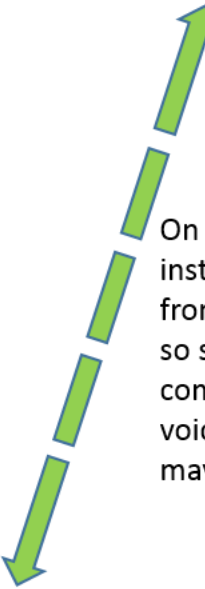

10. MANUAL HANDLING

Mooring operatives should, at all times, follow safe manual handling techniques. Typical things to remember in rope handling are as follows:

- Check travel path to the bollard before pulling, to ensure it is clear and unobstructed. Sometimes you may need to plan your route if there are any fixed obstructions such as a crane, lifebuoy boxes or stowed cargo.
- Keep your back straight at all times.
- Keep elbows as close to the body as possible.
- Keep forearms at elbow height.
- Avoid leaning forwards or backwards.
- Use leg muscles and not your arms or shoulders.
- Keep rope close to the body as possible
- Maintain good body posture and ensure your feet are a decent width apart to remain stable and in control. *Keeping your feet together increase your chance of being pulled over.*

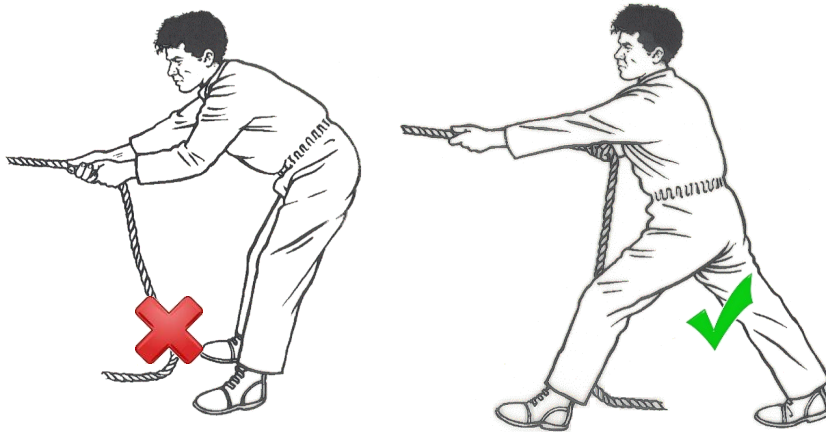

- Ensure you have a secure footing.
- Always transfer your body weight rather than strain your back muscles.

Safe manual handling practice for releasing a mooring rope from a bollard.



STEP 1 – Before letting go of the mooring rope from the bollard, ensure it is fully slacked by the vessel and is laying flat along the quay. If a lot of line is laying in the water it will need to be heaved back up on to the quay to ensure no weight is on the line.



STEP 2 – Bend down so your knees are bent, get close and keep your back straight. Keep hands on the outside of the rope and not on the inside of the eye. Feet should be hip width apart.



Use a second person if necessary to release some of the weight



STEP 3 – As you stand up, keep your back straight and the rope close to the body.



STEP 4 – Lift the line up and over the bollard ensuring the eye is clear of the bollard.



STEP 5 – Do not lean over the bollard to release the line but instead, flip it over, preventing anyone getting caught, allowing it to fall to the ground under its own weight.

FORTH PORTS LIMITED	Document ID PoT PMSC OP13/04	Authorised By Deputy HM	Original Date 10/02/16
Mooring Manual	Date Revised Sep 2024	Revised By AMM	Review Due Sept 2027

Safe manual handling practice for pulling a rope along the quay or berth



STEP 1 – As the mooring rope is lowered from the vessel, it may be useful to pull or guide the rope to the quay to prevent excess rope falling into the water, which will make it heavier.

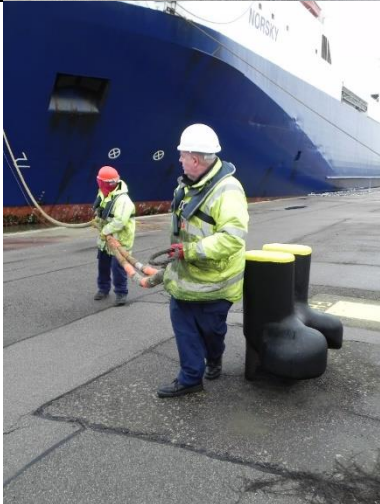

STEP 2 – Keeping a good grip on the line, direct it towards the bollard using additional personnel to assist when necessary. Care should be taken in case the ship's crew unexpectedly pay out suddenly any more rope as this will catch the mooring crew off guard and could lead to them being pulled over. Always watch where you are walking and what the line is doing.

FORTH PORTS LIMITED	Document ID PoT PMSC OP13/04	Authorised By Deputy HM	Original Date 10/02/16
Mooring Manual	Date Revised Sep 2024	Revised By AMM	Review Due Sept 2027

11. SAFETY RECOMMENDATIONS SUMMARY

- **Do not** stand on the edge of the quay to accept a heaving line. stand at a suitable distance from the quay edge so that you can safely see the vessel's crew and **be aware** of the danger of a blow from a 'Monkey's Fist'. **Always wear your Safety Helmet and Lifejacket**
- When heaving a mooring rope ashore, haul a sufficient amount of rope straight onto the quay and then with one or more persons holding the weight, walk the slack rope along the quay to the bollard. When the eye of the rope has been placed on the bollards, tell the person or persons holding the weight to 'let go'.
- **Never** throw the slack of the rope over the quay edge until everybody is clear.
- When carrying a mooring rope, **never** position yourself, or allow others to position themselves on the wrong side of the rope (ie between the rope and quay edge).
- **Do** ensure that when hauling ropes ashore you are not walking into danger, such as potholes, kerbing or moving vehicles. **Always be aware** of what is behind you.
- **Never** stand in or allow others to stand in a loop or 'bight' of any rope.
- **Do** ensure that all ropes are placed correctly on bollards or hooks and that they are not fouled on sharp edges, fenders or equipment on the quayside.
- When mooring/letting go, the rope should be grasped by the side of the eye with the weight supported by another person or persons. **Never** let hands or fingers get between the crown of the eye and the bollard.
- **Avoid** standing next to ropes as the the weight/strain is taken up.
- **Do not** hold onto a rope if you feel a strain come on it. **Immediately** warn your colleagues and drop the rope together.
- **Do** stand clear of the bollards when waiting to 'let go' of a vessel. **Never** sit on a bollard or quay edge. **Always** be alert to what the ship's crew and your colleagues are doing.
- **Do not** go to the bollard or hook until the rope is slack. Then release the rope and stand well clear. **Do not wait near the bollard or hook**. Repeat this procedure for every rope.
- **Do** take extra care when handling wire ropes, as these are notorious for spragging. **Never** let a wire rope slip through your hands and **never** slide you hands along a wire rope. Sprags can inflict very painful injuries.
- **Do** pay attention to the condition of the lifebuoys and 'B' lines positioned on the berths and report if any are missing or defective, to your supervisor. Similarly, defects in quay ladders, fenders, piling etc must also be reported to your supervisor.
- **Always** account for your colleagues. Anyone missing during the course of mooring activities (whether during the day or night) must be reported and a search started.
- **Avoid** standing in line with ropes from ships and tugs, if they part they will usually follow the path in which they were being pulled.
- **Do not take it for granted that your colleagues are safe. Check and be sure.**

FORTH PORTS LIMITED	Document ID PoT PMSC OP13/04	Authorised By Deputy HM	Original Date 10/02/16
Mooring Manual	Date Revised Sep 2024	Revised By AMM	Review Due Sept 2027

APPENDIX 1- LOCKSIDE SPECIFIC INFORMATION

Mooring at lockside consists of the safe securing of vessels either inbound or outbound into the lock or occasionally to secure vessels alongside the 'lead-in' jetties for emergency reasons or to allow for extra tide before entry.

The same practices as stated in this manual apply with the exception of the number of people in the teams. All marine staff are qualified seafarers with many years of practical experience in handling lines. Risk assessments show that fewer personnel are needed with usually three persons per ship movement. A fourth person is called upon for large ships that require the assistance of tugs.

The same principals in safety and manual handling, as written in this manual, still apply to lockside.

Some mooring contractors may opt to provide personnel to fender ship's as they enter the lock. This is usually with the larger vessels to give extra protection to the ship and to lock structures as well. The practice involves a piece of light but sturdy fender being slung on a line and walked along the ship's side as it transits the lock. The mooring contractor providing this does so at their own risk and will have their risk assessment reviewed by the port for that specific operation.

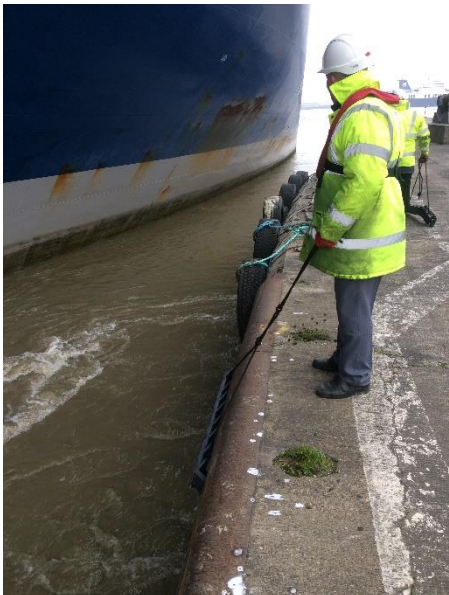

Should any one ever fall into the water during a mooring operation in the lock, there is a risk of that person being crushed by the transitting vessel. Quick action is required to roll the '**crush blocks**', as shown below, into the lock after making sure they are tied to a bollard. **Ensure you do not drop them onto the casualty.** This should allow a safe space for the casualty to be in while a recovery method is put in place.



FORTH PORTS LIMITED	Document ID PoT PMSC OP13/04	Authorised By Deputy HM	Original Date 10/02/16
Mooring Manual	Date Revised Sep 2024	Revised By AMM	Review Due Sept 2027

APPENDIX 2 - LCT SPECIFIC INFORMATION

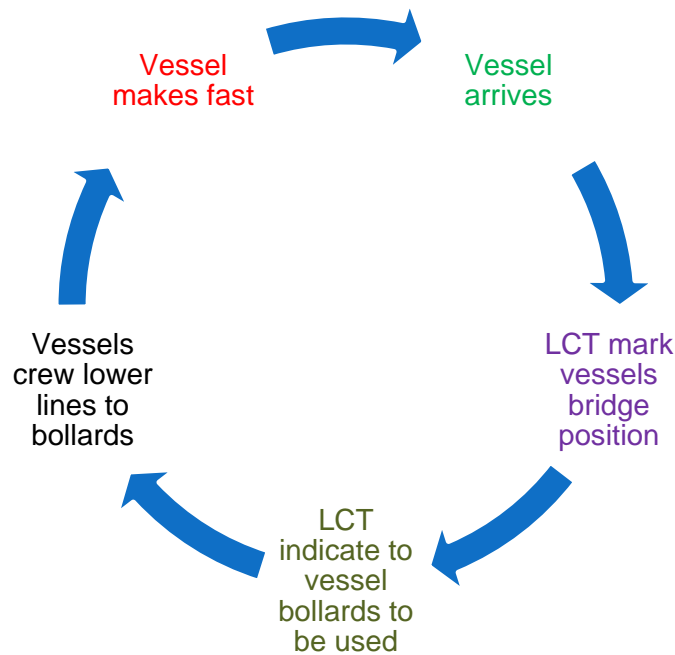

Step One:

Vessel arrives at the port.

The supervisor should check the quay for dangers, ensuring that the quay fenders are in place and that cranes are positioned correctly. Mooring gangs should arrive on the quay prior to the vessel's arrival, having completed their own safety checks.

Step two:

The supervisor should ensure that the Pilot is fully aware of the required vessel position. This is usually done with a bridge marker and via VHF ch77. The supervisor will typically remain in the position where the bridge should be in order to give direction to the Pilot. The supervisor may sometimes need to relocate to either the forward or aft end if there is a particular danger to the mooring crew.

Step three:

When the vessel makes her approach, the Pilot will talk to the supervisor via VHF ch77 to indicate which lines are going to be run first. The supervisor should pass this information onto the mooring gangs forward and aft. Good practice usually mean that a spring and stern line would be run before looking at further lines. At this time mooring gangs should be thinking of what bollards to use ready for the next stage of the process. Its good practice for this to have been worked out prior to the vessel arriving at the port, usually by means of a mooring diagram as shown on the next page.

FORTH PORTS LIMITED	Document ID PoT PMSC OP13/04	Authorised By Deputy HM	Original Date 10/02/16
Mooring Manual	Date Revised Sep 2024	Revised By AMM	Review Due Sept 2027



Vessel Berthing Plan

Date

||
 ||
 ||



Bridge pos.....

+	Vessel name:		M.Party info:		Next HW/LW:		
	Supervisor:		All fast:		Wx conditions:		
		Head Lines	Fwd Springs	Breast Lines	Stern Lines	Aft Springs	Breast Lines
	Type*:						
	Deployed to:						
	Number:						
	Comments: E.g., bunkers, immobilisation, etc.						
	Cranes correctly positioned		Berth inspected and safe				

* S = synthetic, N = nylon, W = wire, P = wire/rope pennant, K = Kevlar



Vessel Berthing Plan

Date 15/12/16

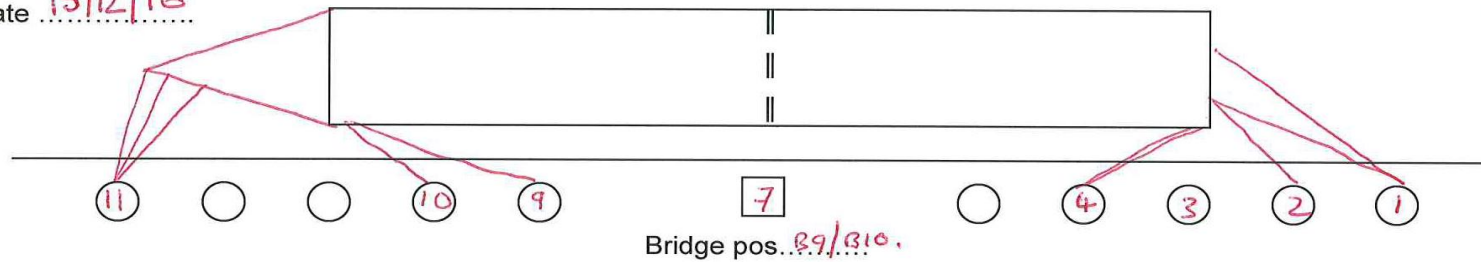

Vessel name:	SAMSKIP COURIER		M.Party info:		Next HW/LW:	0208 / 2017.
Supervisor:	J. BLOGGS.		All fast:	21:30.	Wx conditions:	FAIR
Type*:	Head Lines	Fwd Springs	Breast Lines	Stern Lines	Aft Springs	Breast Lines
Deployed to:	N	N	N	N	N	N
Number:	11	10 + 9		1 + 2	4	
Comments: E.g., bunkers, immobilisation, etc.	3	1 + 1		2 + 1	2	
Cranes correctly positioned	LOA: 140.		Berth inspected and safe		YES.	
	YES					

* S = synthetic, N = nylon, W = wire, P = wire/rope pennant, K = Kevlar

FORTH PORTS LIMITED	Document ID PoT PMSC OP13/04	Authorised By Deputy HM	Original Date 10/02/16
Mooring Manual	Date Revised Sep 2024	Revised By AMM	Review Due Sept 2027

Step Four:

- a) The vessel's crew will lower the mooring lines to the mooring gang, it's very common then to have the vessels crew shout as to where the lines should go. This can be negotiated at the time however the following should be remembered:
 - a. Ropes should be worked from inside to out or outside to in, this will lead to less confusion, especially on departure.
 - b. The bollards can only take a SWL of 150 ton on the new quay and 100ton on the old quay, therefore no more than 3 ropes should be placed on a bollard at any one time.
 - c. Ropes should be spread, when possible, i.e. using more than one bollard.
 - d. Sometimes it may be necessary to dip ropes when another vessel is already using the same bollard.
 - e. On occasions it may not be possible to use another bollard to spread the load, in these circumstances it may be necessary to remove the another ships lines and reposition them before arrival of another so that adequate bollards are available. This is where a mooring plan becomes helpful as well as forward planning.
 - f. Lines should be run out as to give the best / maximum effect, short lines have less stretch and therefore are more likely to part when under load.

Step Five:

The overall making fast of the ship is the responsibility of the master, however this is usually assisted by all involved. If LCT or HDS personnel are clear and confident, then the ships crew will work with you and not against you.

The supervisor should remember that the **Pilot has direct access to the master and his crew**, and if problems arise this is usually the best method of approach.



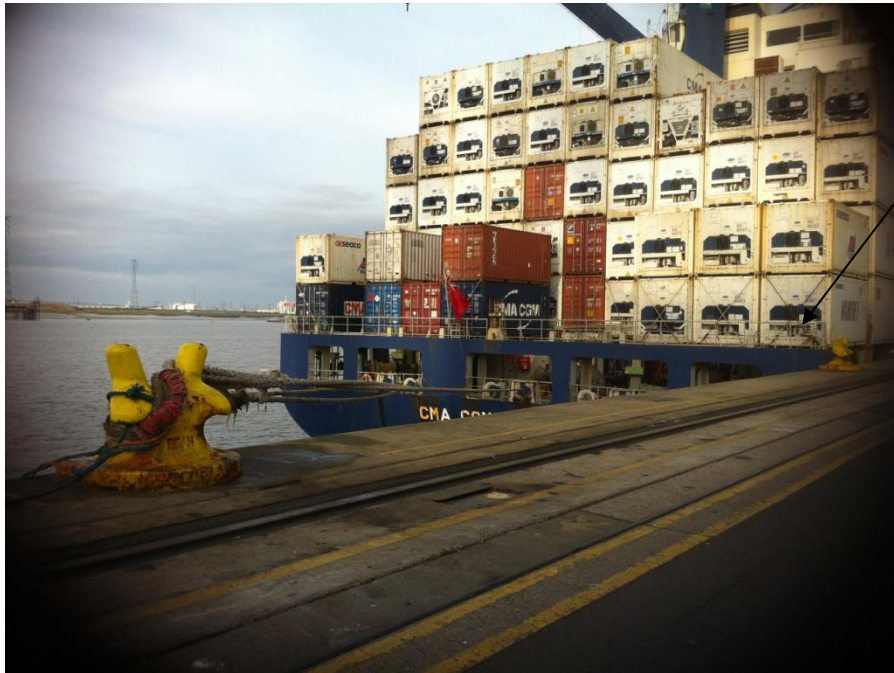

Bollards
not
used?

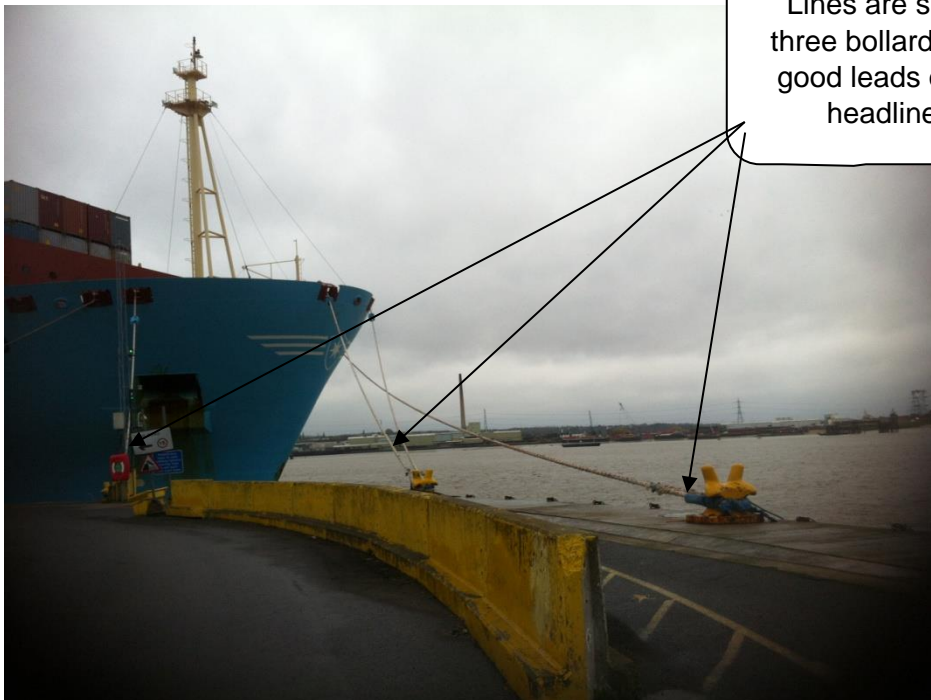

Lines are split to
three bollards, with
good leads on the
headlines.



FORTH PORTS LIMITED	Document ID PoT PMSC OP13/04	Authorised By Deputy HM	Original Date 10/02/16
Mooring Manual	Date Revised Sep 2024	Revised By AMM	Review Due Sept 2027



Lines split to two bollards, which enables another vessel to place ropes on to these bollards, via “dipping” the lines, when berthing astern of this vessel.



Using the Dolphin

Use of the Dolphin is a team effort and should only be used by trained staff.

Check before using the mooring Dolphin, that it is in a safe condition and there is no damage to the access bridge, platform or railings. In cold weather make sure it is free of ice.

Using a Capstan - The use of capstan is only permitted for trained staff and is controlled by a single person using the foot control and the two way switch. See section 7 for specific information on the use of capstans.

Receive the monkeys fist with the heaving line and walk it to the south end of the quay where it will have to be passed around some of the obstacles such as small lamp posts and hand rails. Pass the line to your colleagues until it has been passed on to walkway and walked up to the working platform.



Capstan Winch

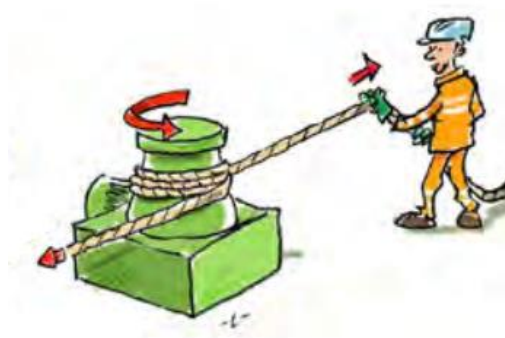

make at least two turns on the winch

FORTH PORTS LIMITED	Document ID PoT PMSC OP13/04	Authorised By Deputy HM	Original Date 10/02/16
Mooring Manual	Date Revised Sep 2024	Revised By AMM	Review Due Sept 2027



Foot Pedal



Emergency & Two-Way Switch

STORM LOCKING QUAY CRANES

When a vessel departs, all quay cranes must be storm locked to the shift manager's instruction.

Your trainer will show you how to long travel the crane along the quay and storm lock.



FORTH PORTS LIMITED	Document ID PoT PMSC OP13/04	Authorised By Deputy HM	Original Date 10/02/16
Mooring Manual	Date Revised Sep 2024	Revised By AMM	Review Due Sept 2027

APPENDIX 3- EDC SPECIFIC INFORMATION



EDC receives scheduled calls by regular Shipping Lines who operate the same regular vessels. All vessels use the stern ramp for discharge to quay, and berthing entails those vessels crossing two expanses of water on the port-side known locally as the 'Dry Dock' and the 'Old Lock '

Bollards required to moor on this berth are positioned in three locations, separated by the aforementioned expanses of water and require a vehicle to access (only two locations are normally required, 26 & 29 berths)

Due to their regularity the same mooring bollards are used by all vessels with Pilots aware of local berthing plans.

Pre-Arrival

1. A Mooring Team is allocated by a Vessel Supervisor from the available certified EDC Operative labour and they are advised of the ETA at the Lock.
2. Prior to the mooring/unmooring operation a Vessel Supervisor must complete a visual pre-work area check to ensure the quayside is free of any potential hazards, such as housekeeping issues which could cause slip, trip, falls or obstructions.
3. A Vessel Supervisor should visually check that the bollards are in good condition. Any identified damage or faults to be reported immediately to the relevant Line Manager.
4. A Vessel Supervisors must visually check that the Mooring Team are correctly wearing the life jackets and gloves provided, ensuring that any waist belt or crotch straps fitted are correctly adjusted as per manufactures recommendations
5. A Vessel Supervisors must ensure that each member of the mooring team is provided with a two-way radio prior to arriving at the area of work and conduct a full radio check to ensure that all radios are fully functional and communicating with each other.
6. A Vessel Supervisor must ensure that a communication system be established between the Mooring Team & the Vessel Crew. This should be via VHF Radio (and also include hand signals and verbal communication)
7. Two Mooring Teams, consisting of a minimum of two persons each (2 men per rope) should be deployed to their required locations in advance of a vessel arriving at the quay for berthing.
8. The Forward End bollards are set within a berth secured by fencing and a number coded locked gate for access. The Mooring Team deployed to this end must be aware of the gate code so as not to delay berthing

Mooring Operation

During the mooring/letting go of the vessel a least one Vessel Supervisor must supervise the operation to ensure that the Mooring Team is working safely and that the correct procedures including the correct manual handling techniques are being followed. (A Vessel Supervisor may form part of the Mooring Team)

The Vessel Supervisor/s will also be in regular contact with the ships command via VHF radio to ensure any arising problems are communicated at the earliest opportunity.

Mooring

1. As the vessel makes her approach the Vessel Supervisor will establish via VHF radio which ropes will be let go first. The Vessel Supervisor will in turn communicate this information to the Mooring Team via local EDC two-way radios

FORTH PORTS LIMITED	Document ID PoT PMSC OP13/04	Authorised By Deputy HM	Original Date 10/02/16
Mooring Manual	Date Revised Sep 2024	Revised By AMM	Review Due Sept 2027

2. The Mooring Team should also establish visual and verbal contact with Vessel Crew prior to the ropes being released.
3. Once the ropes are lowered the Mooring Team must work in tandem to haul in the heaving line and transport the ropes to the planned bollard, taking care to adopt correct manual handling techniques when doing so, as per training.
 - a. A boat-hook must be used to retrieve wayward monkey's fists / heaving lines that may be in the water or snagged on security fencing. This is located on the fencing at the Forward End and the fence by the Goosenecks
4. The Mooring Team should always hold ropes on the outside of the eye when placing over the bollard, releasing at the earliest opportunity.
5. Ropes should be dipped when required for quick release on bollards requiring more than one rope. No bollard should exceed three ropes.
6. Once all ropes are in place the Vessel Crew will indicate that they are good to make fast and the Mooring Team should retreat, but stay within the vicinity for a short period of time to react should there be an issue.

Regular Mooring Plan for EDC Vessels

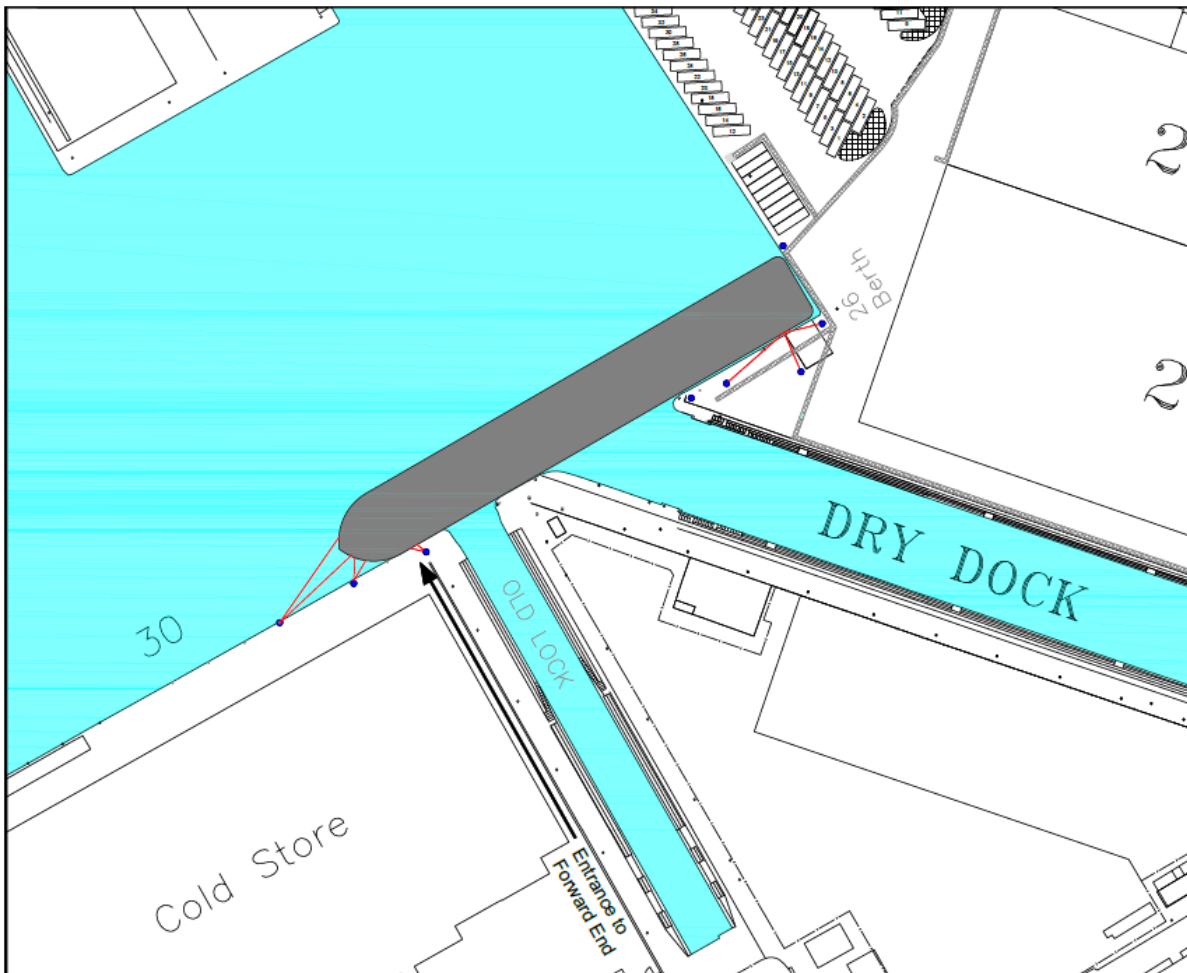

Letting Go

With a pre-planned ETD the Mooring Team will be on standby ready for departure

FORTH PORTS LIMITED	Document ID PoT PMSC OP13/04	Authorised By Deputy HM	Original Date 10/02/16
Mooring Manual	Date Revised Sep 2024	Revised By AMM	Review Due Sept 2027

1. Once vessel operations are completed the Vessel Crew will advise the Vessel Supervisor, either by VHF radio or verbally that the vessel is ready to sail.
2. Two Mooring Teams, consisting of a minimum of two persons each (2 men per rope) should be deployed to their required locations in readiness for the vessel departure.
3. Once the Mooring Teams are in place (clear of the rope) and visual contact is made with the Vessel Crew the ropes will be slackened.
4. Once slackened ropes should be removed from the bollards. The Mooring Team should always hold ropes on the outside of the eye when lifting over the bollard and release to ground at the earliest opportunity.
5. Once all ropes are released the Mooring Team should retreat, but stay within the vicinity for a short period of time to react should there be an issue and the vessel needs to be re-moored

FORTH PORTS LIMITED	Document ID PoT PMSC OP13/04	Authorised By Deputy HM	Original Date 10/02/16
Mooring Manual	Date Revised Sep 2024	Revised By AMM	Review Due Sept 2027

APPENDIX 4- RO-RO BERTH SPECIFIC INFORMATION

Berthing of vessels on the Ro Ro is only carried out by approved contractors at the discretion of the Harbour Master. Individual contracting companies will decide whether their teams should be trained on the use of the capstans or not and this decision is to be documented in their Risk Assessment & Method Statement. If individual contracting companies do not wish to use the capstans they can still continue to moor vessels at the RoRo berth using the heaving lines provided to transfer mooring lines from line boats to the slip hooks.

The nominated supervisor should always position themselves in line with the vessel's stern and be readily apparent to the pilot so that he has a visual means of knowing where the vessel's stern is. Good communication is needed to count them down into position. The use of a different colour hard hat would greatly assist the pilot in being able to identify the supervisor.

When using a lineboat it is important that care is taken not to leave too much slack in the water on which the boat can foul its propeller. Lines should be passed up from the lineboat to the dolphin using a heaving line that is lowered down to the rope. **DO NOT** throw the line down as this increase the chance of excess line entering the water. Lower it down gently.

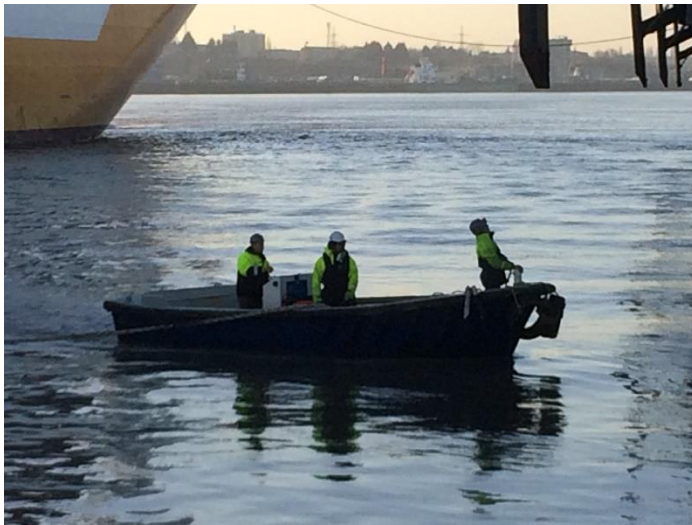

FORTH PORTS LIMITED	Document ID PoT PMSC OP13/04	Authorised By Deputy HM	Original Date 10/02/16
Mooring Manual	Date Revised Sep 2024	Revised By AMM	Review Due Sept 2027

APPENDIX 5- LANDING STAGE SPECIFIC INFORMATION

Berthing vessels on the Landing Stage is only carried out by approved contractors at the discretion of the Harbour Master. All contractors need to be aware of how the passenger walkways are operated so that they are not damaged when berthing a ship.

All personnel should be wearing lifejackets when on the outside of the fog chain fence and be aware of uneven surfaces at all times.

Cruise terminal staff will have agreed a mooring plan for the vessel in advance of its call and will place a bridge marker in place prior to arrival.

Two fences at the end of the landing stage form part of the ISPS cordon fence. On occasions the fence is fouled by mooring lines. Therefore the end sections are hinged so that they can be secured back in order to not to rest or damage the ropes.

FORTH PORTS LIMITED	Document ID PoT PMSC OP13/04	Authorised By Deputy HM	Original Date 10/02/16
Mooring Manual	Date Revised Sep 2024	Revised By AMM	Review Due Sept 2027

ANNEX 1 - USEFUL KNOTS

1.3 BOWLINE

A **bowline** creates a very secure loop in the end of a piece of rope or line. When under load it does not slip and is difficult to untie.

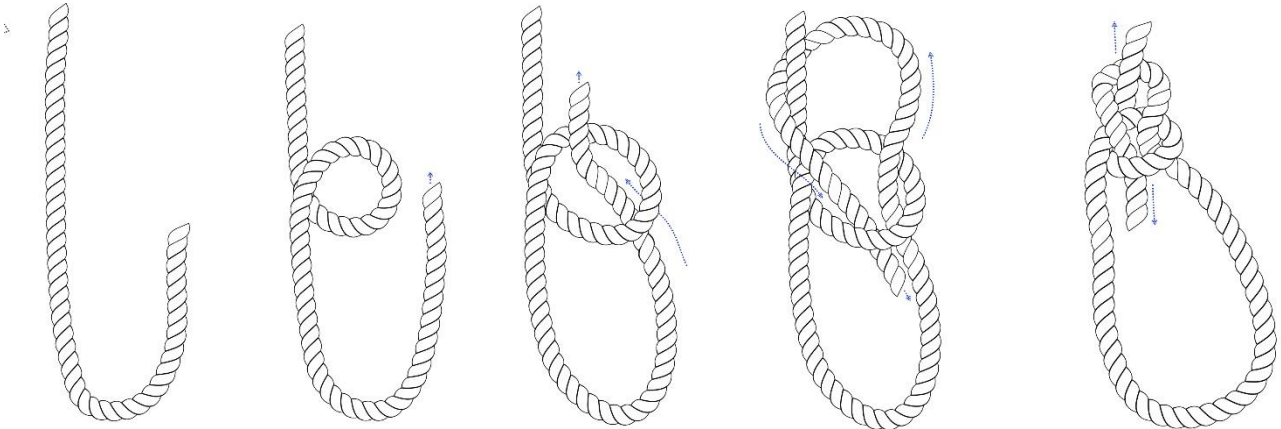

1.4 RUNNING BOWLINE

The **running bowline** is simply a bowline, tied as above but around its own standing part, thus forming a noose as in Fig 8.

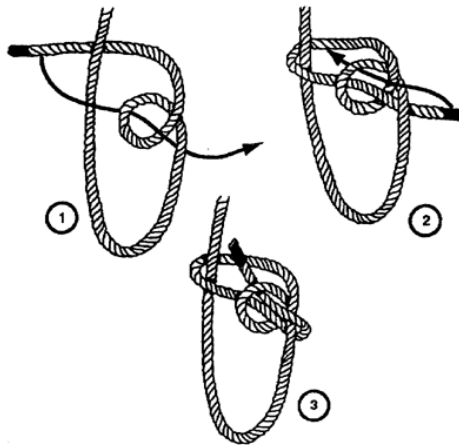

1.5 SINGLE SHEET BEND

Usually used to tie a heaving line to a mooring rope tail or any smaller rope to a thicker rope.

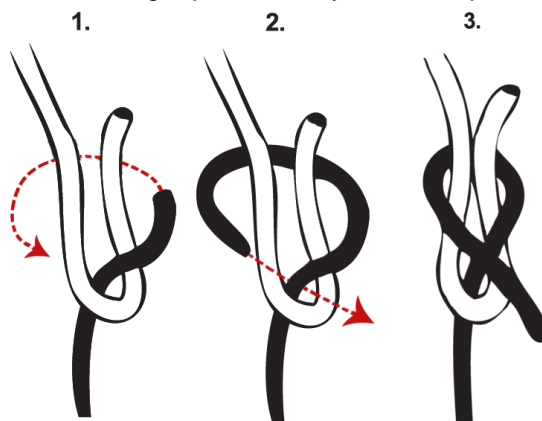

FORTH PORTS LIMITED	Document ID PoT PMSC OP13/04	Authorised By Deputy HM	Original Date 10/02/16
Mooring Manual	Date Revised Sep 2024	Revised By AMM	Review Due Sept 2027

1.6 DOUBLE SHEET BEND

Usually used to tie a heaving line to a mooring rope tail or any smaller rope to a thicker rope.

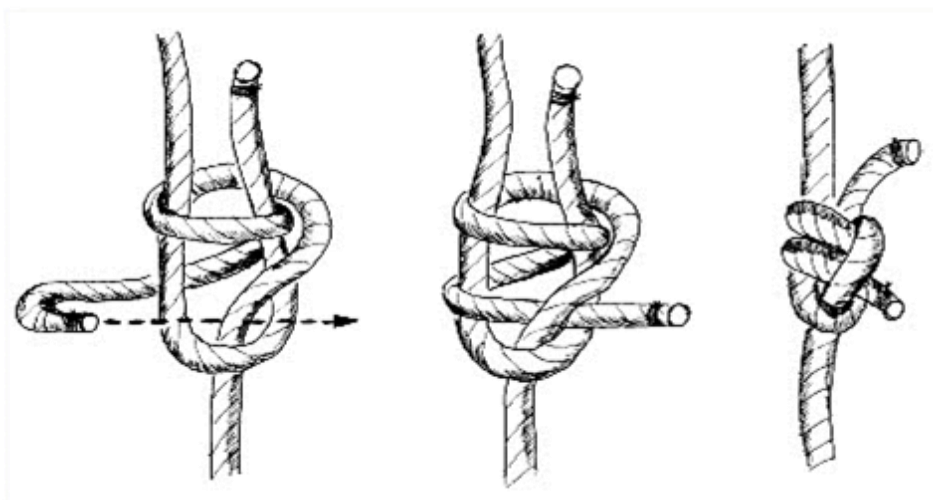

1.7 ROUND TURN & TWO HALF HITCHES.

Useful knot to make something fast such as securing a coiled heaving line when not in use.

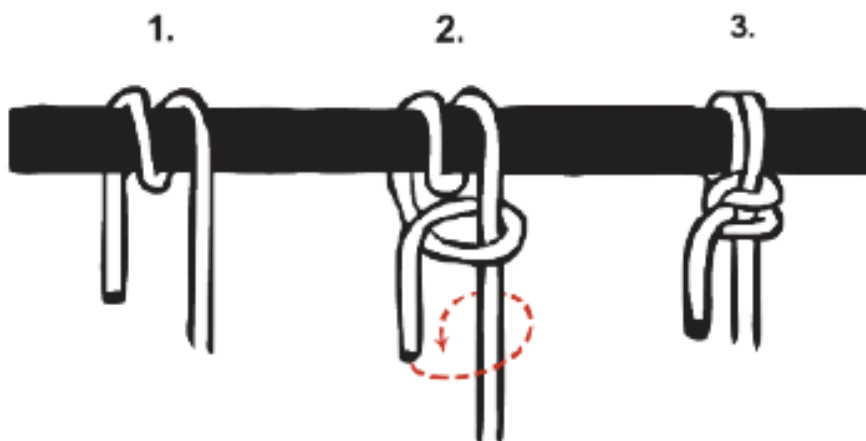

FORTH PORTS LIMITED	Document ID PoT PMSC OP13/04	Authorised By Deputy HM	Original Date 10/02/16
Mooring Manual	Date Revised Sep 2024	Revised By AMM	Review Due Sept 2027

1.8 HOW TO COIL A ROPE

By coiling rope properly you can easily pick it up and use it as a heaving line quickly without having to wind it up. A coil of rope is also less likely



Laid ropes should be coiled clockwise



The trick to coiling rope is to twist each loop until the line lays flat



As the coil finishes pull a bight through



Pull it over the top



Drop it down and pull up the bitter end



FORTH PORTS LIMITED	Document ID PoT PMSC OP13/04	Authorised By Deputy HM	Original Date 10/02/16
Mooring Manual	Date Revised Sep 2024	Revised By AMM	Review Due Sept 2027

ROPES & MOORINGS

Dos & DON'Ts







DO use the correct rope.	DON'T stand in bights
DO visually inspect ropes	DON'T slip moorings under excess tension
DO use correct securing points	DON'T use suspect ropes (Report them)
DO wear correct PPE	DON'T abuse ropes.
DO use the best lead	DON'T stand on the wrong side of (especially when crossing ropes) rope leads
DO use capstan correctly	DON'T throw ropes/heaving lines blind
DO use trip hooks correctly	DON'T leave inexperienced persons unsupervised.
DO report defects	DON'T stand close to drum when working capstan.
DO stow and coil ropes/heaving lines neatly	DON'T wear rings.
DO be aware of operations going on around you.	

**THINK
BE SURE
BE SAFE**

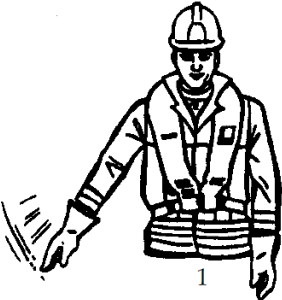
FORTH PORTS LIMITED	Document ID PoT PMSC OP13/04	Authorised By Deputy HM	Original Date 10/02/16
Mooring Manual	Date Revised Sep 2024	Revised By AMM	Review Due Sept 2027

Always wear a lifejacket

ANNEX 3 - COMMON HAND SIGNALS

	
<p>An outstretched arm with hand open and flat being waved downwards means "slack off".</p>	<p>A sharp upward movement of the arm with the hand cupped towards the signaller means "let go" or "cast off".</p>
	
<p>Crossed arms in front of the body means "make fast" or "is made fast".</p>	<p>A circular movement of the hand above the head means "heave away".</p>
	
<p>Both hands raised above the shoulders, with open hands facing forward means "stop".</p>	<p>A raised hand with the fist being clenched and unclenched means "heave or hoist slowly" (inching).</p>

FORTH PORTS LIMITED	Document ID PoT PMSC OP13/04	Authorised By Deputy HM	Original Date 10/02/16
Mooring Manual	Date Revised Sep 2024	Revised By AMM	Review Due Sept 2027